

Author: AA Yudanarko	Legal owner:	Scale: 1:20	Sheet: 1/7
Appr.: Anhar R, Indra Adji S		Toler.:	Size: A4
Layout Lapangan untuk Test Project		Drawing no.:	
LKS SMK 2023 Mobile Robotics		Date:	Revision:
Document type: Layout		2023-03-24	REV A

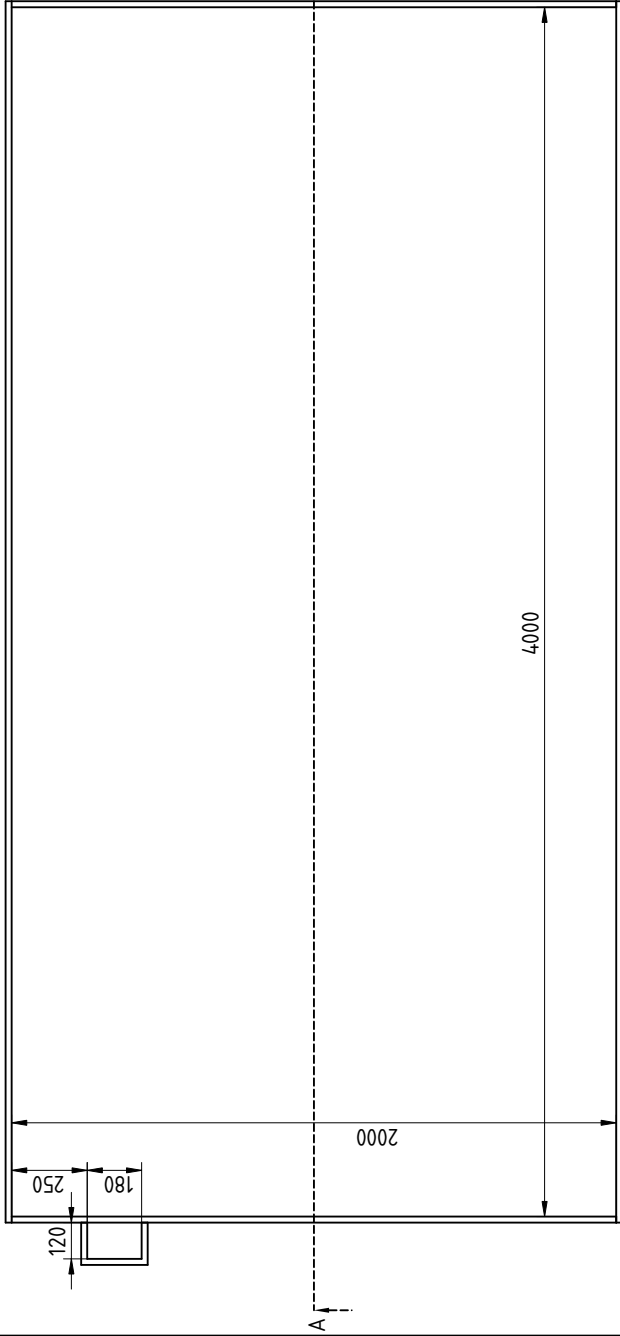

(R) DO NOT DUPLICATE THIS DRAWING TO THIRD PARTIES WITHOUT OWNER'S PERMISSION !



Atas

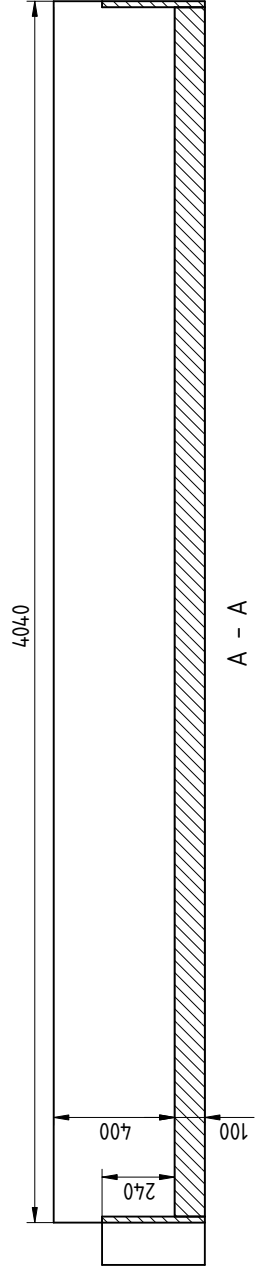
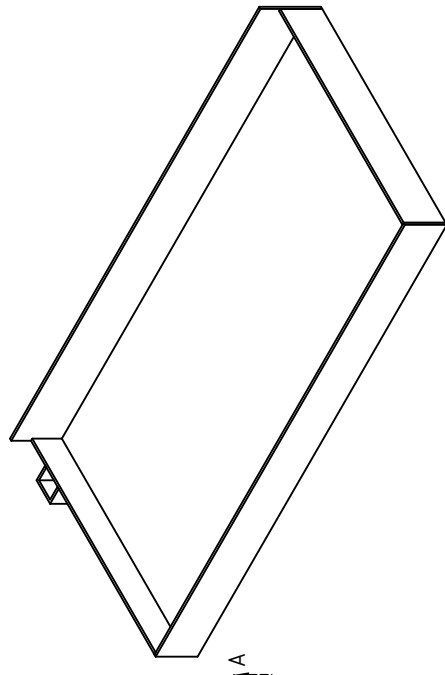

A - A

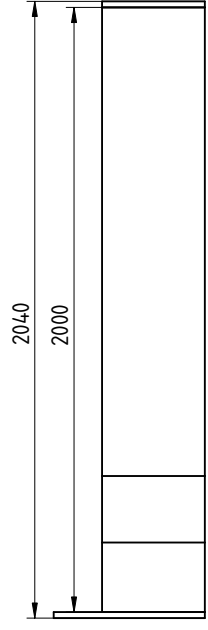

Kiri

Bahan multiplex/plywood tebal 20mm
 Permukaan lantai dilapisi melamin warna putih
 Permukaan sisi samping dinding warna putih
 Permukaan sisi atas dinding warna hitam

Author: AA Yudanarko	Legal owner:	Scale: 1:25	Sheet: 2/7
Appr.: Anhar R, Indra Adji S		Toler.:	Size: A4
Lapangan		Drawing no.:	
LKS SMK 2023 Mobile Robotics		Date:	Revision:
Document type:		2023-03-24	REV A



(R) DO NOT DUPLICATE THIS DRAWING TO THIRD PARTIES WITHOUT OWNER'S PERMISSION !

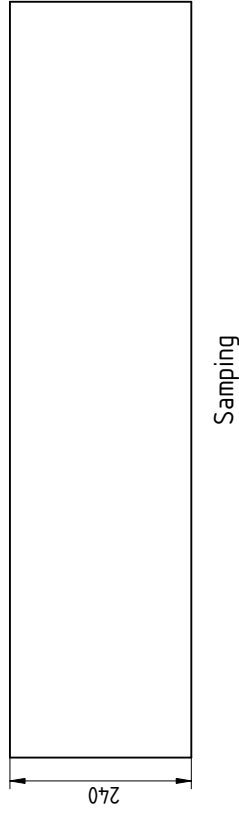
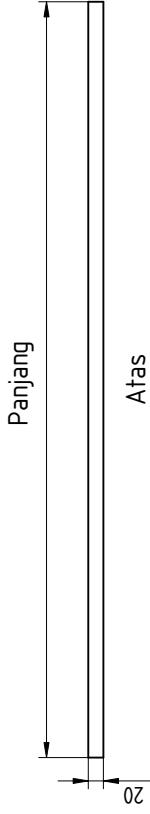

Panjang (mm)	Banyak (potong)
1400	1
1000	1
800	1
680	2
400	2
300	2

Bahan multiplex/plywood
tinggi 240 mm, tebal 20 mm
sisi samping warna putih
sisi atas warna hitam

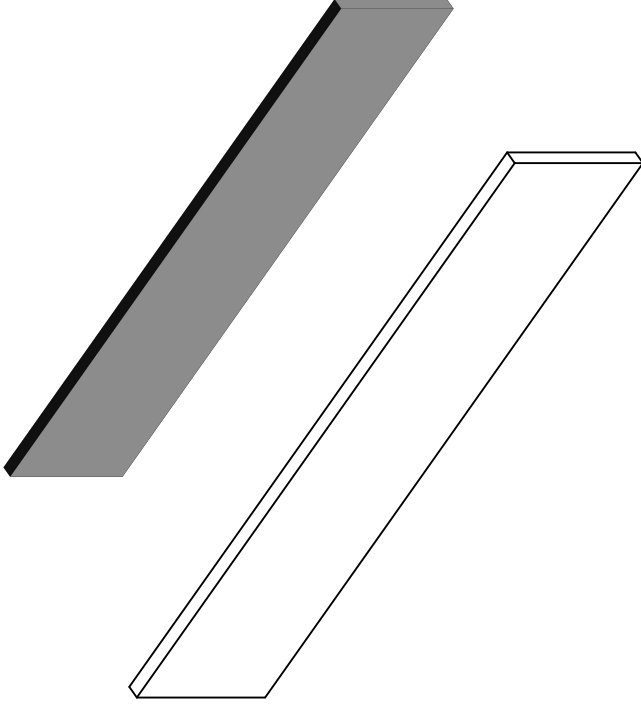

Author: AA Yudanarko	Legal owner:	Scale: 1:10	Sheet: 3/7
Appr.: Anhar R, Indra Adji S		Toler.:	Size: A4
Dinding Partisi (Obstacle)		Drawing no.:	
LKS SMK 2023 Mobile Robotics		Date:	Revision:
Document type:		2023-03-24	REV A
(R) DO NOT DUPLICATE THIS DRAWING TO THIRD PARTIES WITHOUT OWNER'S PERMISSION !			



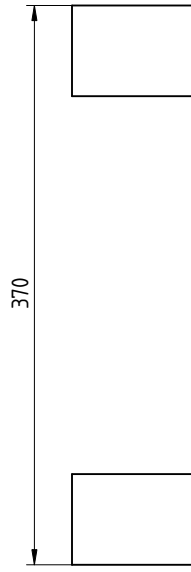
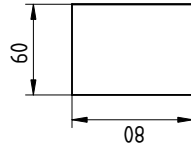
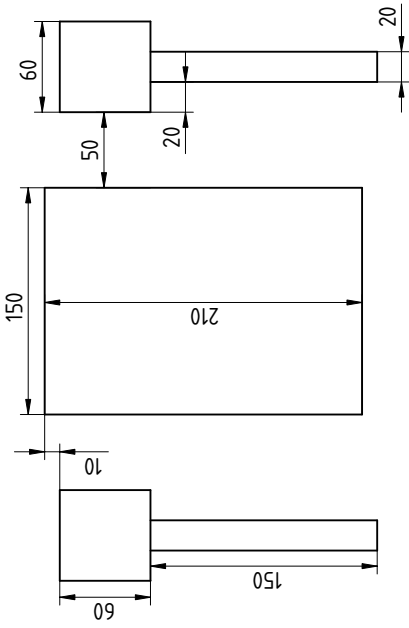
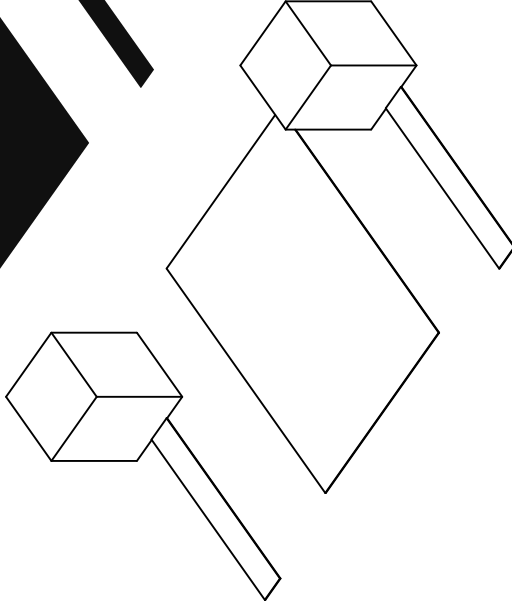
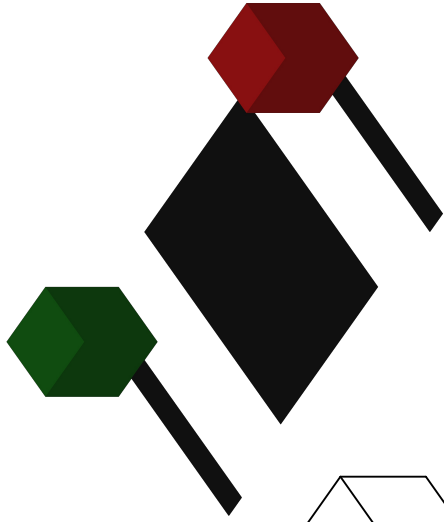

Author: AA Yudanarko	Legal owner:	Scale: 1:5	Sheet: 4/7
Appr.: Anhar R, Indra Adji S		Toler.:	Size: A4
Kamar Pasien		Drawing no.:	
LKS SMK 2023 Mobile Robotics		Date:	Revision:
Document type:		2023-03-24	REV A
(R) DO NOT DUPLICATE THIS DRAWING TO THIRD PARTIES WITHOUT OWNER'S PERMISSION !			



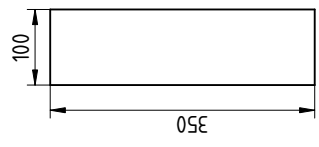
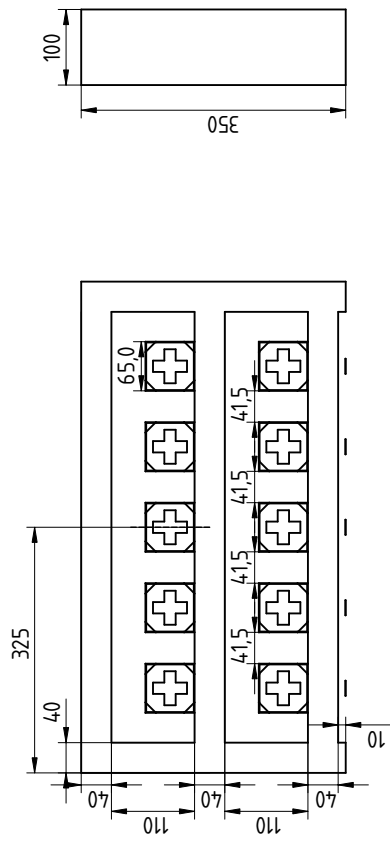
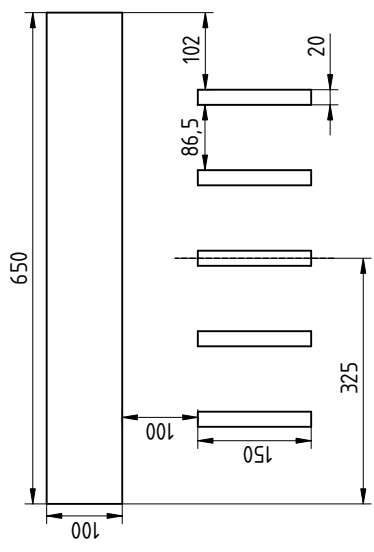
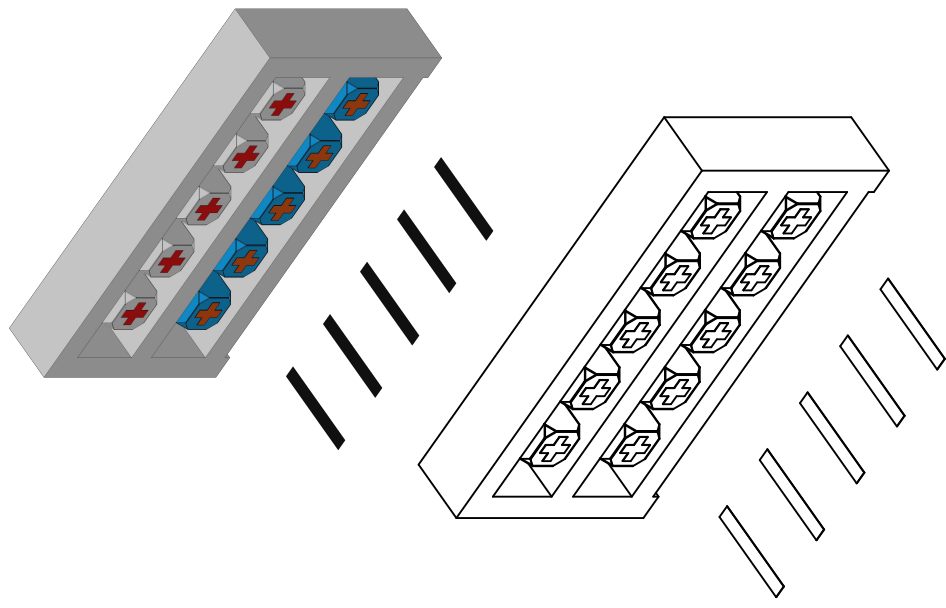

Author: AA Yudanarko	Legal owner:	Scale: 1:10	Sheet: 5/7
Appr.: Anhar R, Indra Adji S		Toler.:	Size: A4
Rak Obat		Drawing no.:	
LKS SMK 2023 Mobile Robotics		Date:	Revision:
Document type:		2023-03-24	REV A
(R) DO NOT DUPLICATE THIS DRAWING TO THIRD PARTIES WITHOUT OWNER'S PERMISSION !			



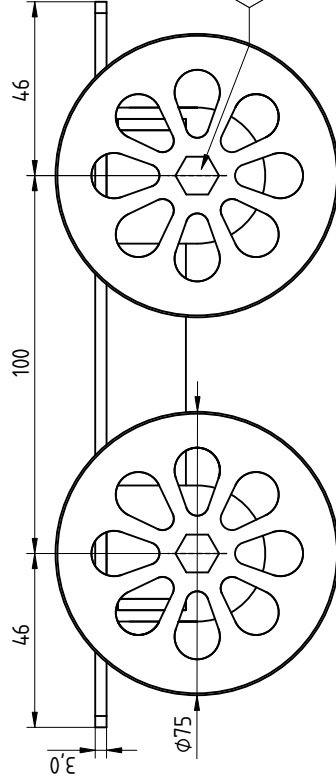
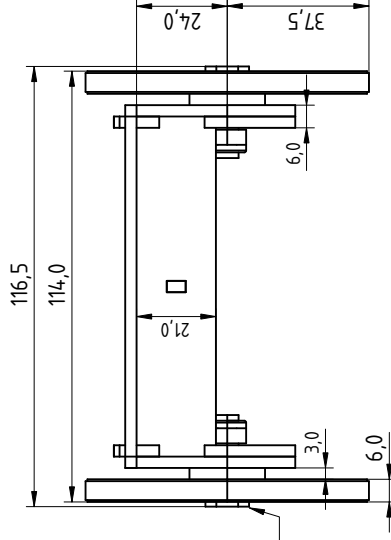
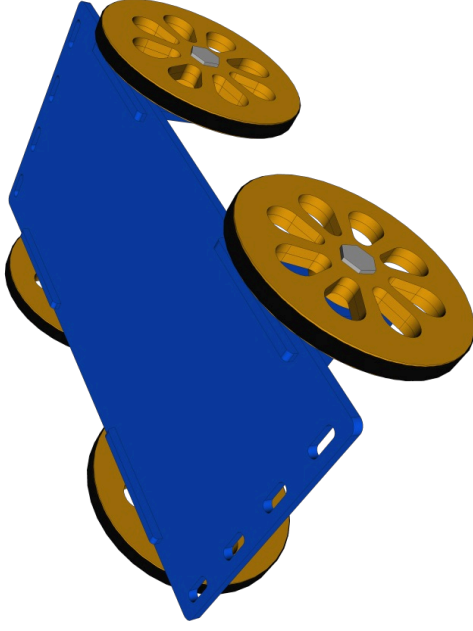
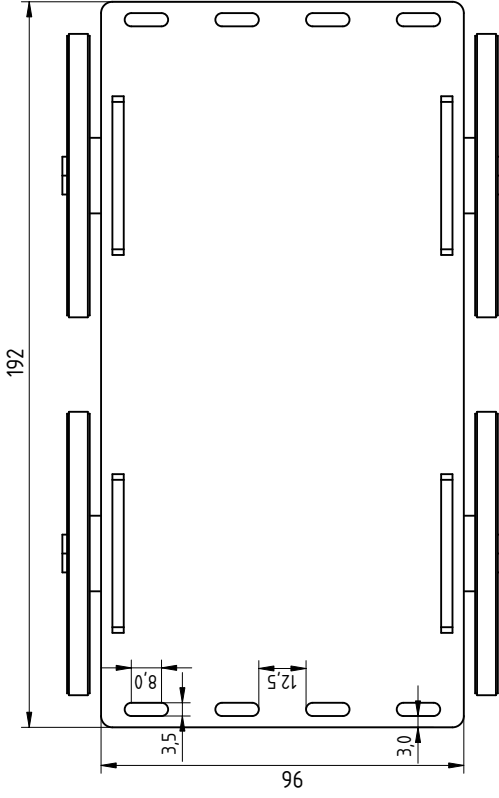

Author: AA Yudanarko	Legal owner: KOKARO	Scale: 1:2	Sheet:
Appr.: Anhar R, Indra Adji S		Toler.:	Size: A4
Gurney (Brankar)		Drawing no.:	Revision:
LKS SMK 2023 Mobile Robotics		Date:	REV B
Document type: Mechanical assembly drawing		2023-04-30	
(R) DO NOT DUPLICATE THIS DRAWING TO THIRD PARTIES WITHOUT OWNER'S PERMISSION !			



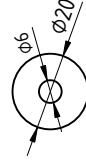
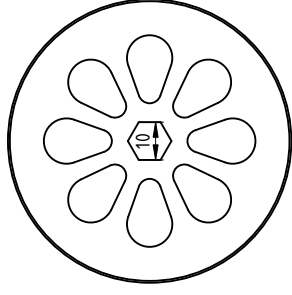
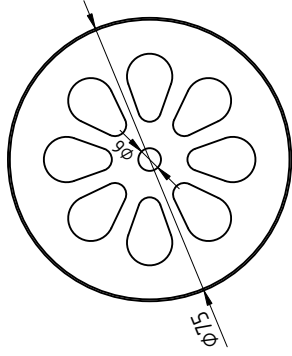
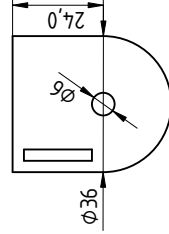
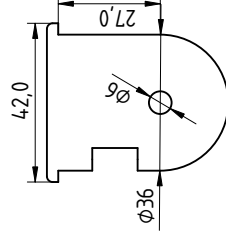
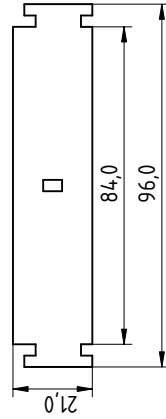
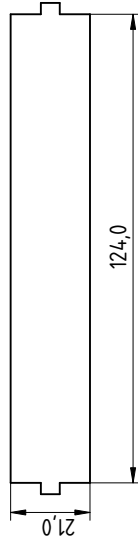
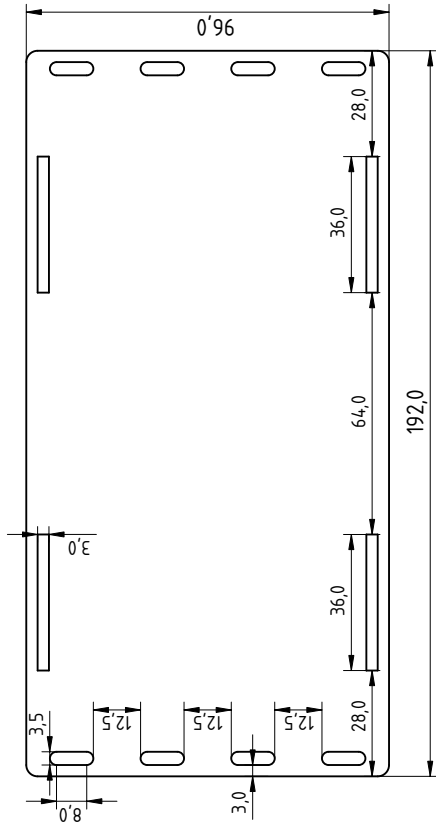

Mur+Baut
M6x20

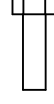

Author: AA Yudanarko	Legal owner: KOKARO	Scale: 1:2	Sheet:
Appr.: Anhar R, Indra Adjij S		Toler.:	Size: A4
Gurney (Brankar) Parts		Drawing no.: DN	
LKS SMK 2023 Mobile Robotics		Date: 2023-04-30	Revision: REV B
Document type: Mechanical assembly drawing			
(R) DO NOT DUPLICATE THIS DRAWING TO THIRD PARTIES WITHOUT OWNER'S PERMISSION !			

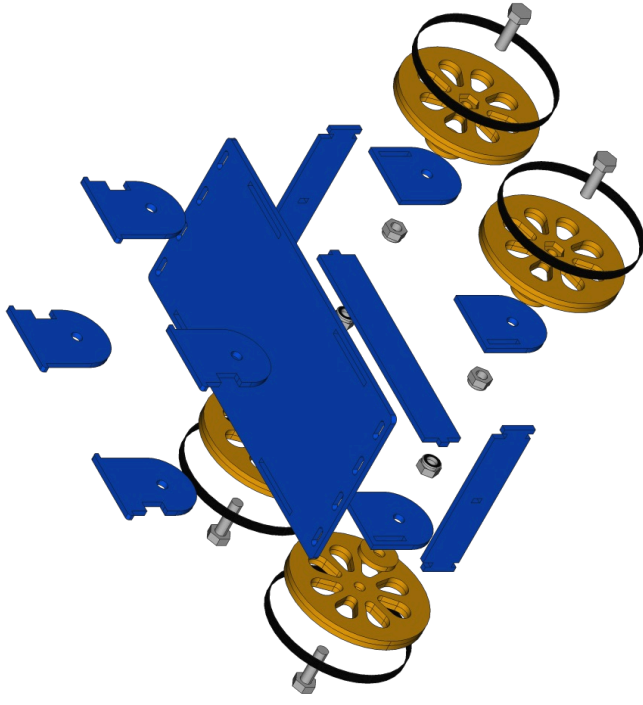
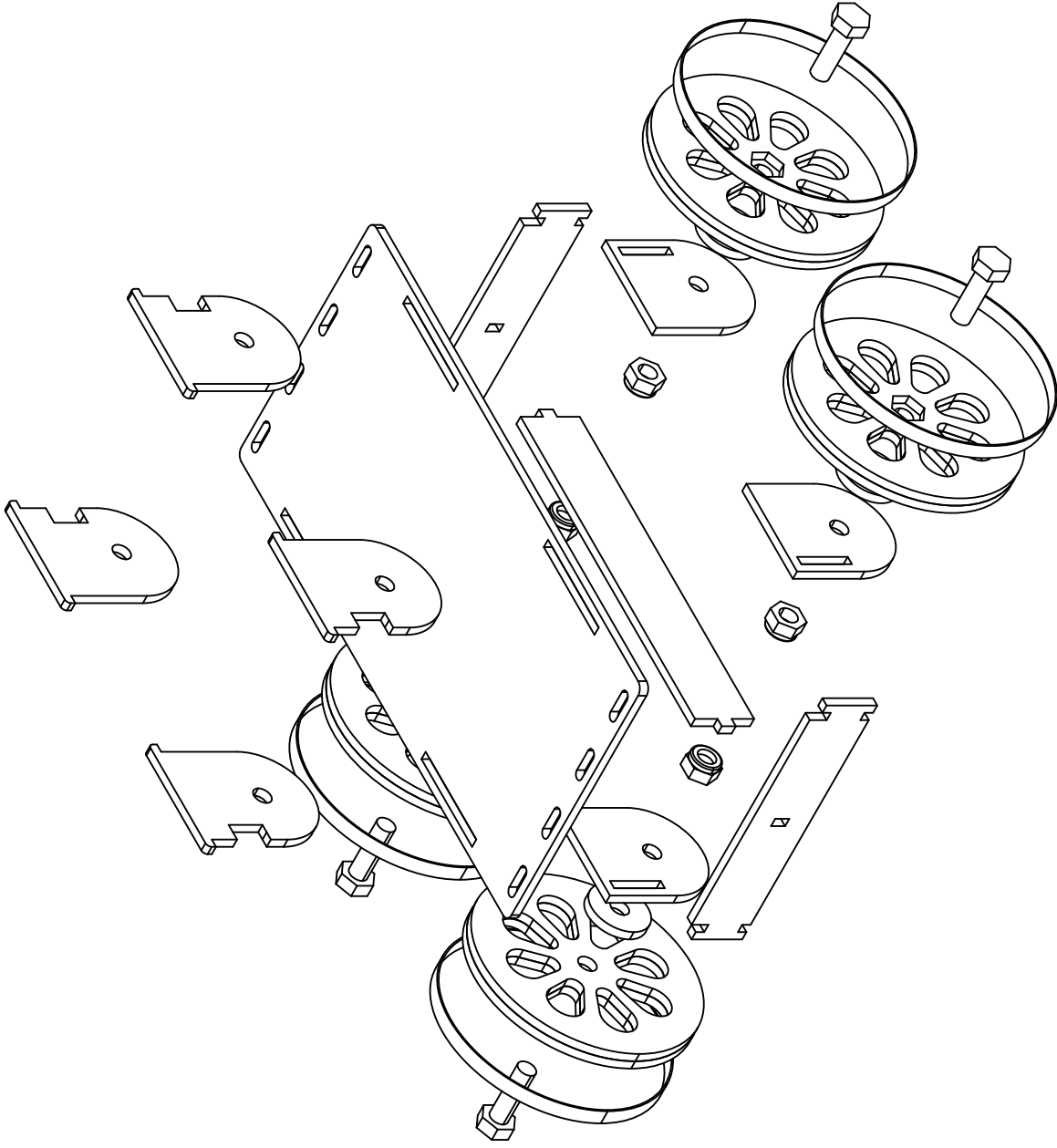

Author: AA Yudanarko	Legal owner: KOKARO	Scale: 1:2	Sheet:
Appr.: Anhar R, Indra Adji S		Toler.:	Size: A4
Gurney (Brankar)		Drawing no.:	
LKS SMK 2023 Mobile Robotics		Date:	Revision:
		2023-04-30	REV B
Document type: Mechanical assembly drawing			
(R) DO NOT DUPLICATE THIS DRAWING TO THIRD PARTIES WITHOUT OWNER'S PERMISSION !			



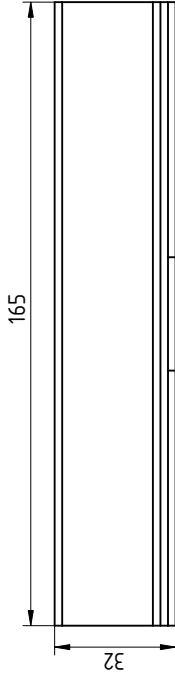

Atas

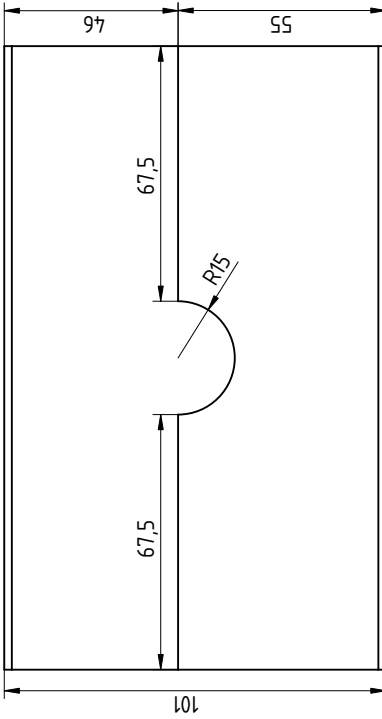

Depan

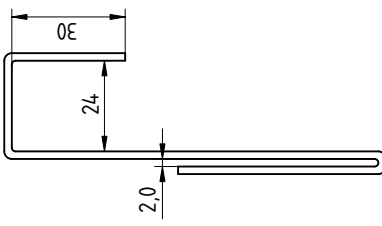

Samping

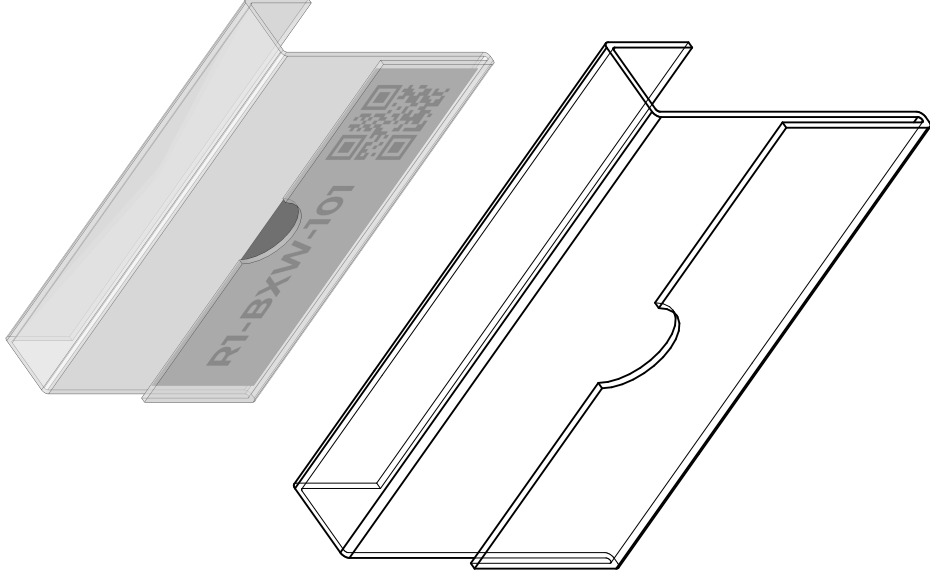

Bahan akrilik bening (clear)
tebal 2mm

Author: AA Yudanarko	Legal owner:	Scale: 1:2	Sheet: 7/7
Appr.: Anhar R, Indra Adji S		Toler.:	Size: A4
Kotak QR Code		Drawing no.:	
LKS SMK 2023 Mobile Robotics		Date:	Revision:
Document type:		2023-03-24	REV A
(R) DO NOT DUPLICATE THIS DRAWING TO THIRD PARTIES WITHOUT OWNER'S PERMISSION !			



Dicetak di kertas stiker ukuran A4 skala 100%, tanpa tepi halaman. Tempel pada kertas yang lebih tebal kemudian dipotong dan dilipat mengikuti garis panduan.



— garis potong
- - - garis lipat

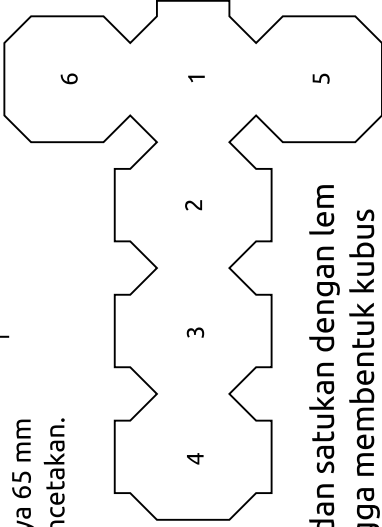
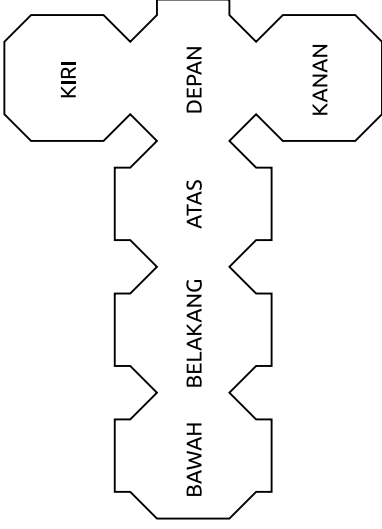
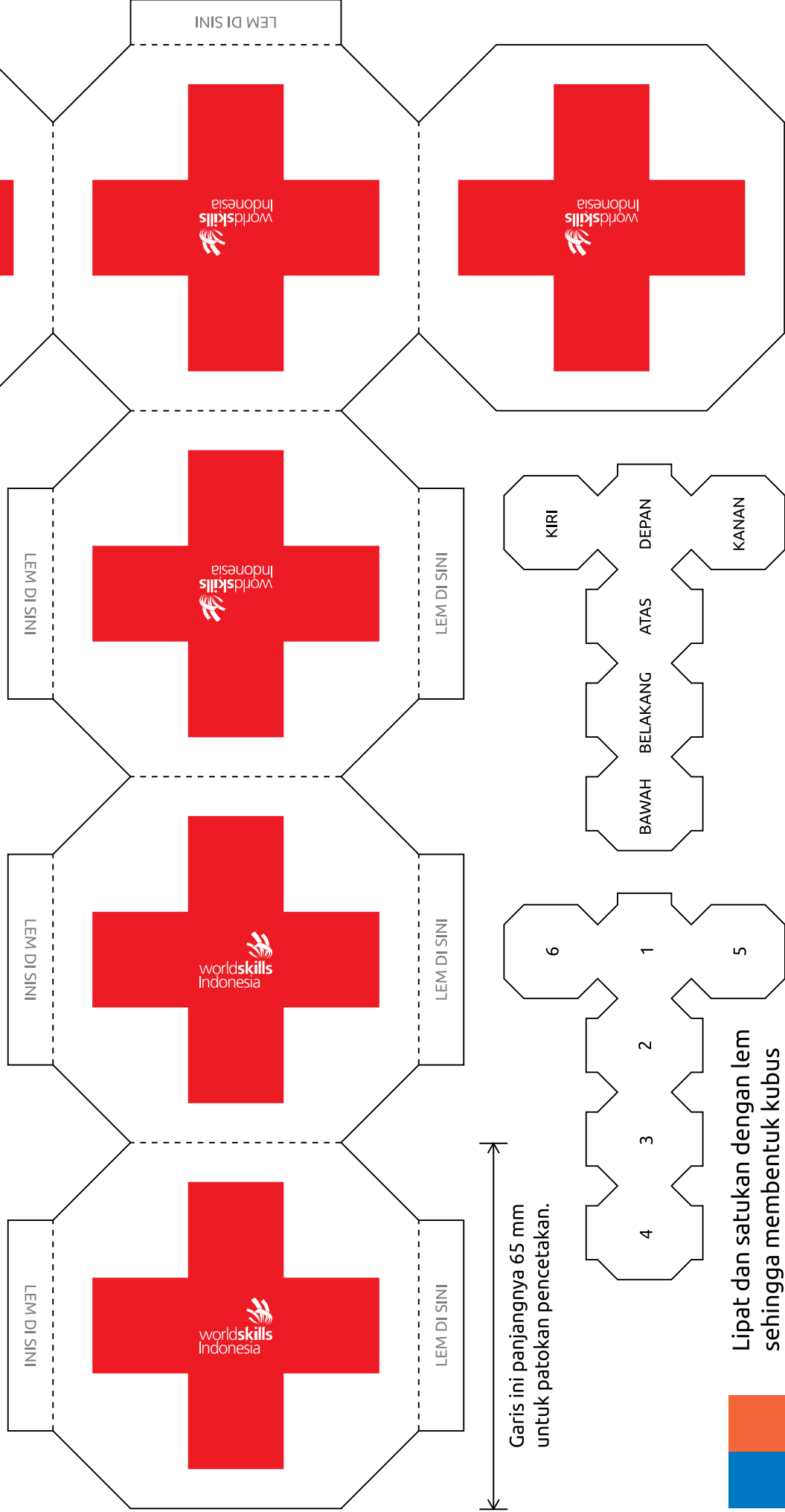

Garis ini panjangnya 65 mm untuk patokan pencetakan.

Lipat dan satukan dengan lem sehingga membentuk kubus





Dicetak di kertas stiker ukuran A4 skala 100%, tanpa tepi halaman. Tempel pada kertas yang lebih tebal kemudian dipotong dan dilipat mengikuti garis panduan.



— garis potong
- - - garis lipat

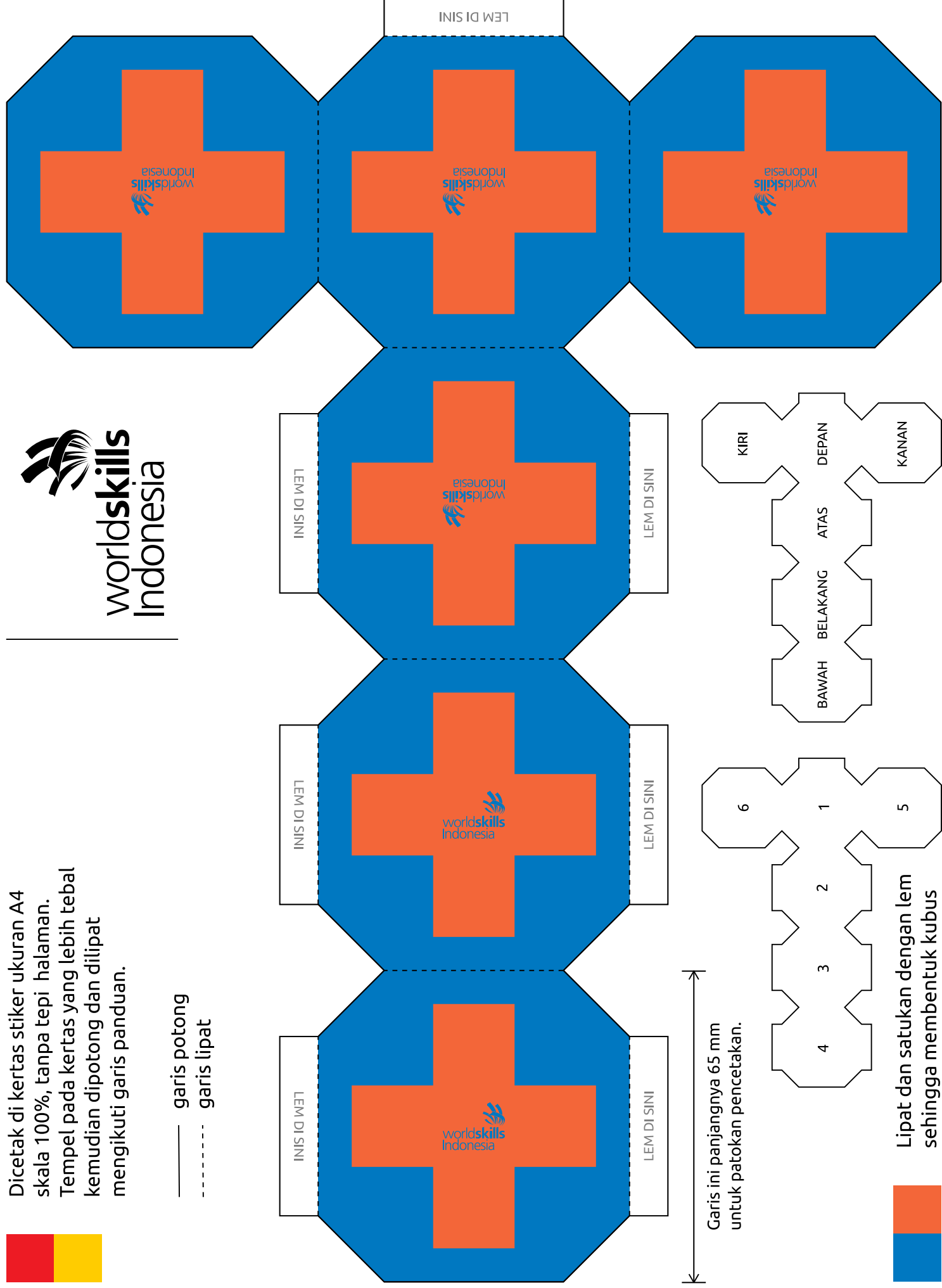

Garis ini panjangnya 65 mm untuk patokan pencetakan.

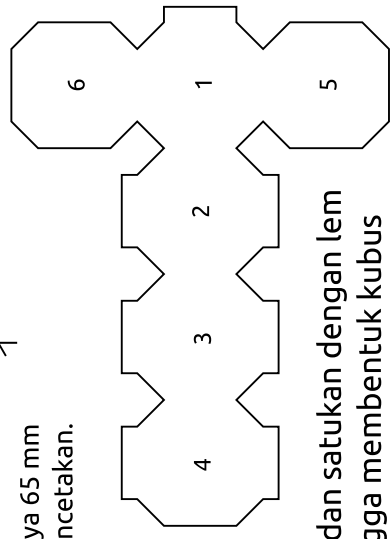

Lipat dan satukan dengan lem sehingga membentuk kubus

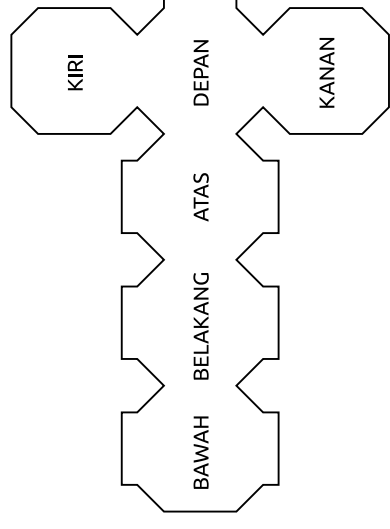



Dicetak di kertas stiker ukuran A4 skala 100%, tanpa tepi halaman. Tempel pada kertas yang lebih tebal kemudian dipotong dan dilipat mengikuti garis panduan.



— garis potong
- - - garis lipat

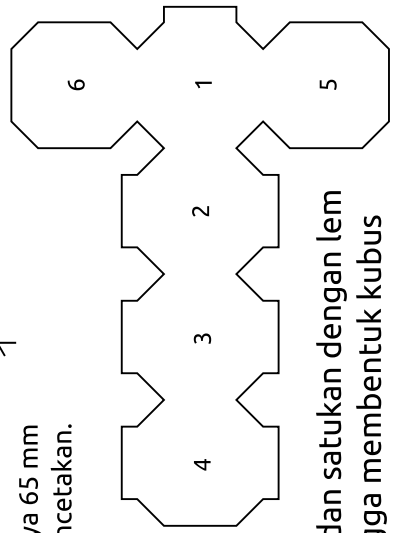
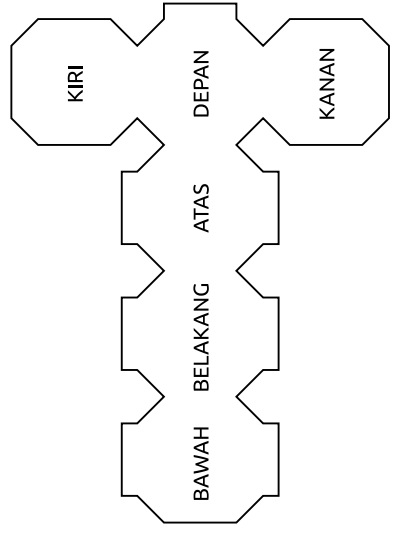
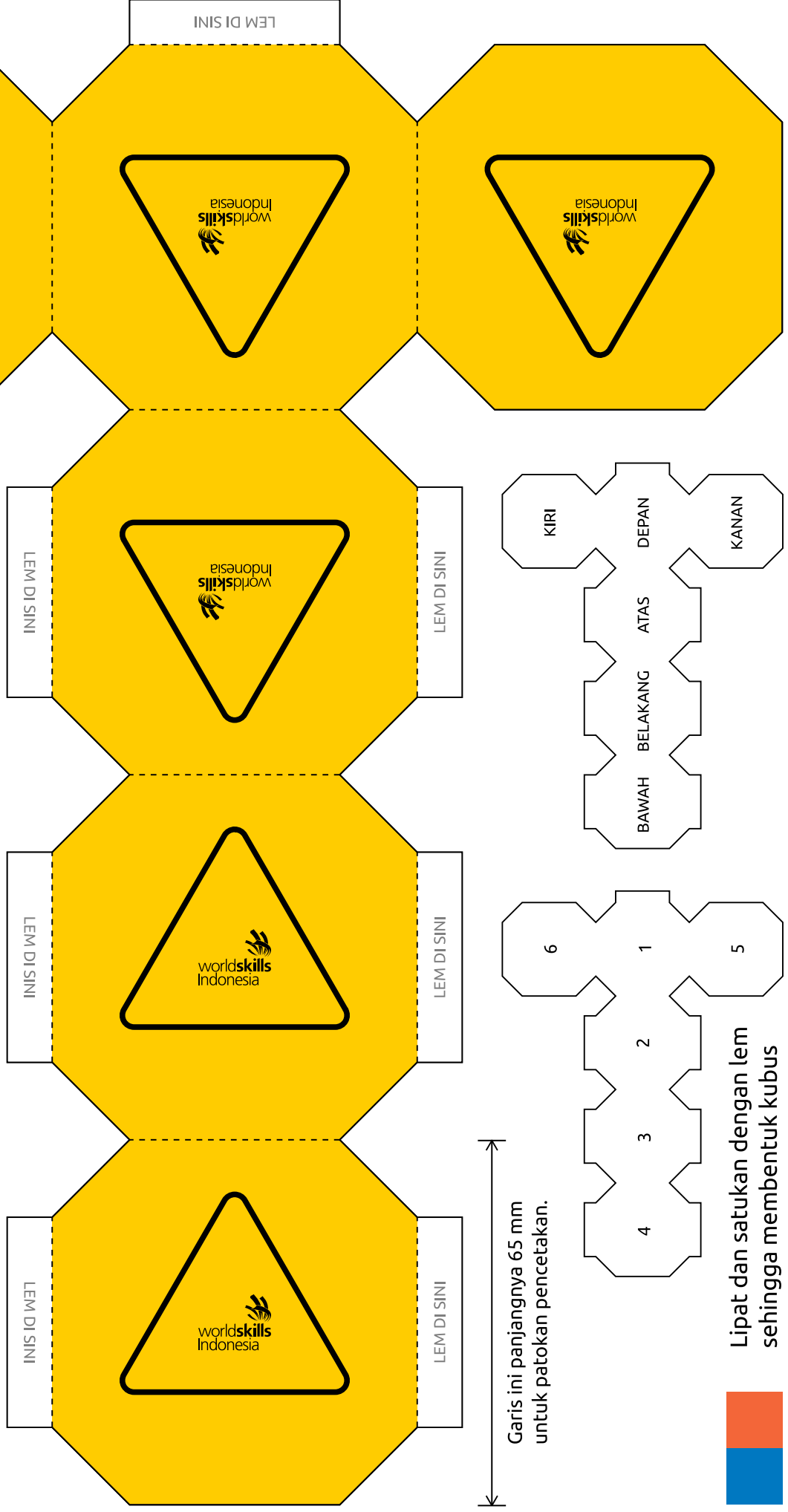

Garis ini panjangnya 65 mm untuk patokan pencetakan.

Lipat dan satukan dengan lem sehingga membentuk kubus

